

# OVERVIEW FINISHING OPTIONS

Issue 06.2018 –  
Replaces 09.2016

## **AIREX®** structural foam core material

- / FlexiCut (FC)
- / ContourKore, knife cut (CK kc)
- / ContourKore, saw cut (CK sc)
- / Mini ContourKore (MCK)
- / Grooved & Perforated (GP)
- / Perforated 30 (P30)
- / Grooved 50 (G50)
- / AIREX® SealX surface sealing (SX)
- / Precision Thickness (PRE)

## **BALTEK®** structural balsa core material

- / CountourKore (CK)
- / Adaptive ContourKore (ACK)
- / ContourKore (CK), combination cut

### Rating of Finishing Options regarding specific requirements

most suitable ●●●

suitable ●●

ok ●

**FlexiCut (FC)**

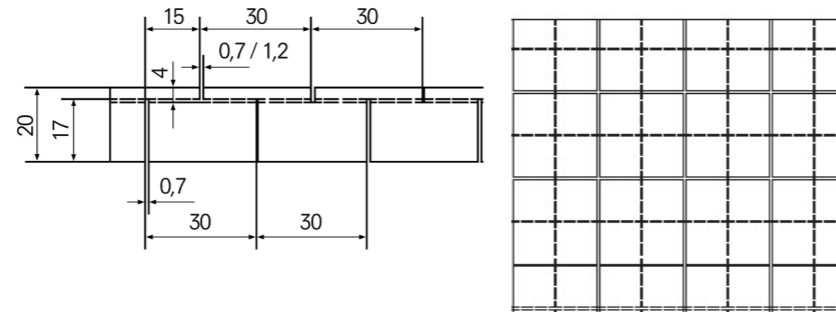
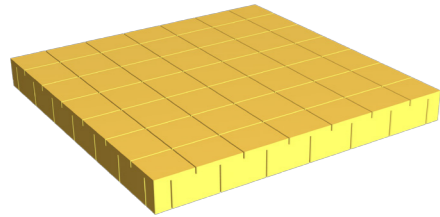

- / 30 x 30 mm cross-grooved both sides (40 x 40 mm for sheets > 31 mm)
- / kerf depth 85% / 20% of thickness
- / kerf width 0.7 mm for sheets ≤ 35 mm
- / kerf width 1.2 mm for sheets ≤ 50 mm
- / 2'200 holes / m<sup>2</sup>

Sheet flexibility ●● Resin uptake ●● Promotes resin flow in infusion ●● Laminate surface quality ●●● (0.7 mm width)

**ContourKore, knife cut (CK kc)**

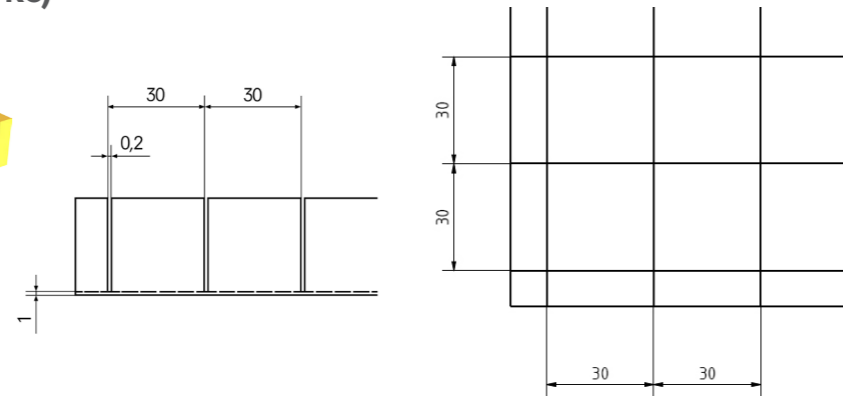
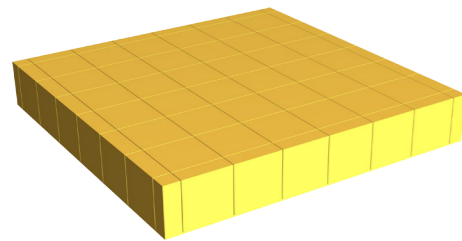

- / 30 x 30 mm bloc pattern
- / kerf width approx. 0.2 mm
- / glass fiber cloth on bottom side of sheet
- / blocs are cut almost down to cloth

Sheet flexibility ●●● Resin uptake ●●● Promotes resin flow in infusion ●●● Laminate surface quality ●●●

**ContourKore, saw cut (CK sc)**

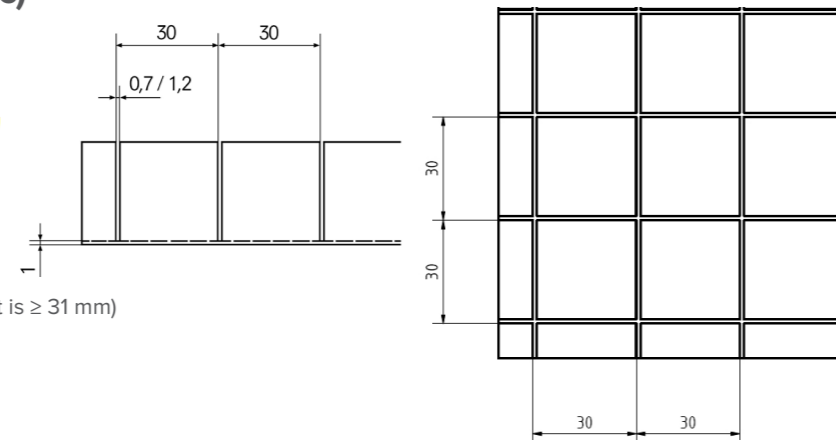
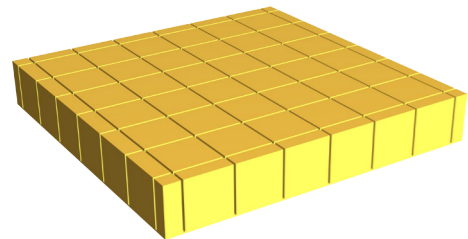

- / 30 x 30 mm bloc pattern (40 x 40 mm if sheet is ≥ 31 mm)
- / kerf width 0.7 mm for sheets ≤ 30 mm
- / kerf width 1.2 mm for sheets ≤ 50 mm
- / glass fiber cloth on bottom side of sheet
- / blocs are cut almost down to cloth

Sheet flexibility ●●● Resin uptake ●●● Promotes resin flow in infusion ●●● Laminate surface quality ●●●

**Note:** limitations of availability may apply for specific products, densities or thicknesses

**Mini ContourKore (MCK)**

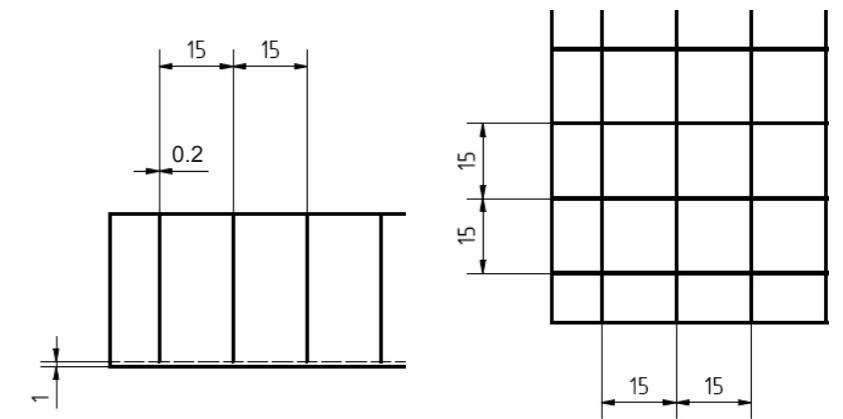
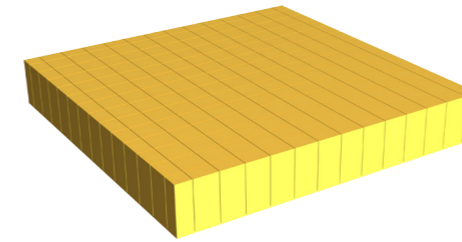

- / 15 x 15 mm bloc pattern
- / kerf width approx. 0.2 mm
- / glass fiber cloth on bottom side of sheet
- / blocs are cut almost down to cloth

Sheet flexibility ●●● Resin uptake ●●● Promotes resin flow in infusion ●●● Laminate surface quality ●●●

**Grooved & Perforated (GP)**

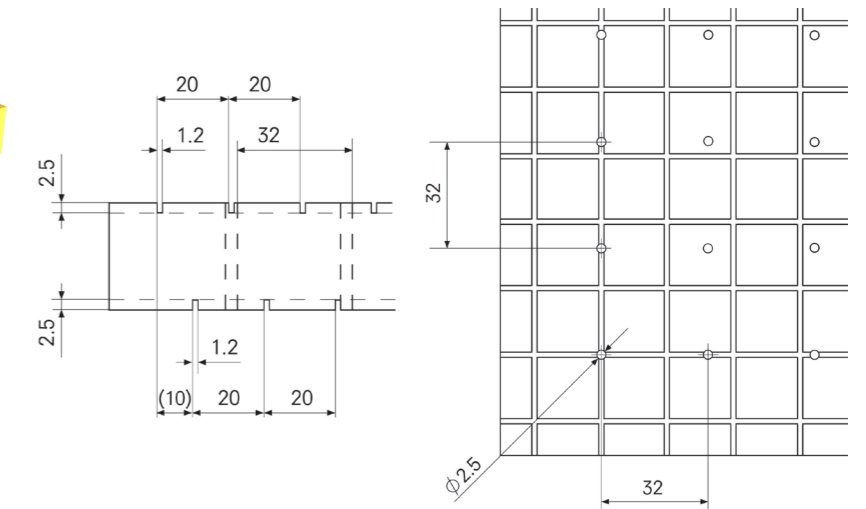
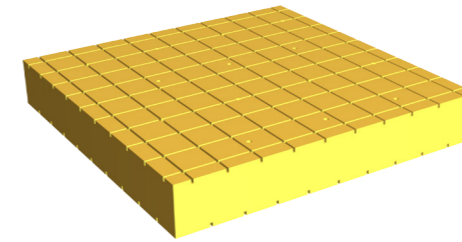

- / cross-grooved both sides
- / groove width 1.2 mm, depth approx. 2.5 mm
- / grooving distance 20 mm
- / grooving offset both sides 10 mm
- / holes (diameter 2.5 mm)
- / hole distance 32 x 32 mm pattern
- / holes may not be aligned with grooves

Sheet flexibility ●●● Resin uptake ●●● Promotes resin flow in infusion ●●● Laminate surface quality ●●●

**Perforated 30 (P30)**

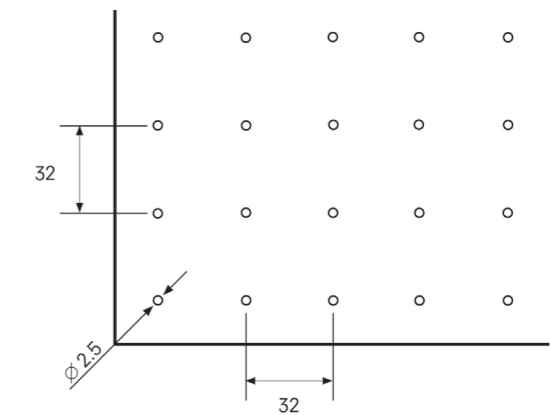
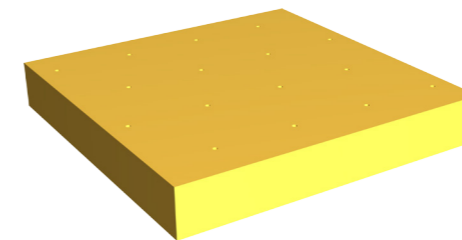

- / holes (diameter 2.5 mm)
- / hole distance 32 x 32 mm pattern

Sheet flexibility ●●● Resin uptake ●●● Promotes resin flow in infusion ●●● Laminate surface quality ●●●

**Note:** limitations of availability may apply for specific products, densities or thicknesses

**Grooved 50 (G50)**

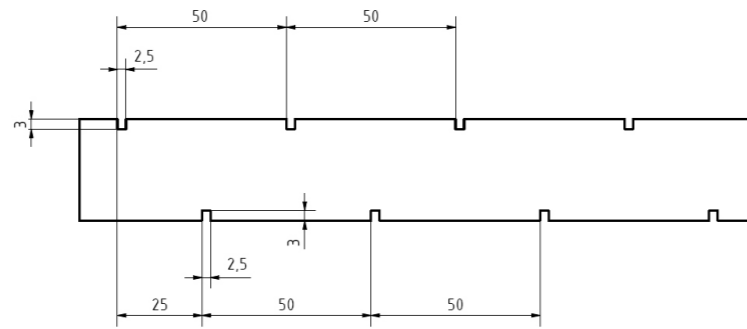
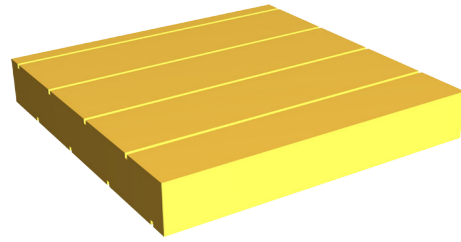

- / parallel or crosswise grooves
- / one side or both sides
- / grooving distance 50 mm
- / groove depth approx. 3 mm
- / groove width 2.5 mm

Sheet flexibility   Resin uptake ●●   Promotes resin flow in infusion ●   Laminate surface quality ●

**AIREX® SealX surface sealing (SX)**

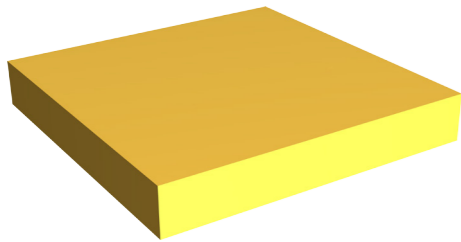

- / surface sealing for AIREX® PET foams
- / available for AIREX® T90 and T92 (densities up to 130 kg/m³)
- / designed for resin infusion
- / considerable reduction of resin uptake in infusion processes

Sheet flexibility   Resin uptake ●●●   Promotes resin flow in infusion   Laminate surface quality

**Precision Thickness (PRE)**

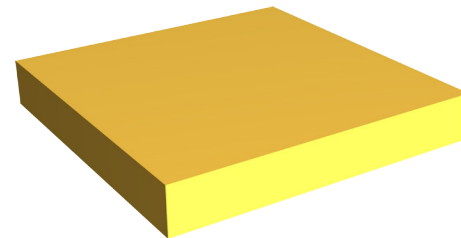

- / improved thickness tolerance of sheet:
- / PRE1: +0.2 / -0.4 mm (0.6 mm range)
- / PRE2: +0.1 / -0.2 mm (0.3 mm range)

**Note:** limitations of availability may apply for specific products, densities or thicknesses

**ContourKore (CK)**

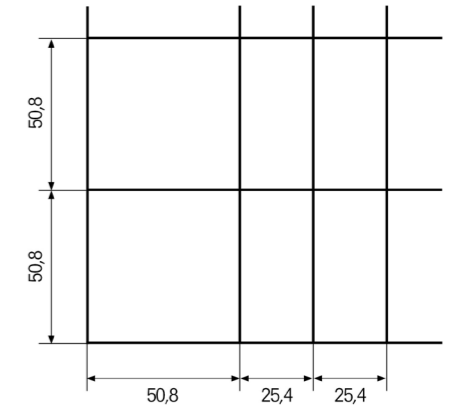
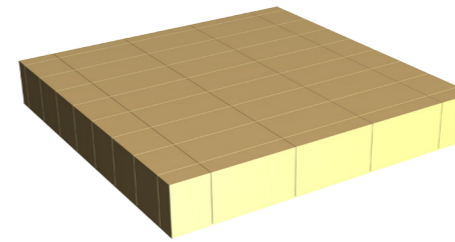

- / 25.4 x 50.8 mm bloc pattern (50.8 x 50.8 mm first and last row)
- / kerf width approx. 0.2 mm (knife cut)
- / glass fiber cloth on bottom side of sheet
- / blocs are cut almost down to cloth
- / 6.4 - 44.5 mm thickness

Sheet flexibility ●●●   Resin uptake ●●●   Promotes resin flow in infusion ●●   Laminate surface quality ●●●

**Adaptive CountourKore (ACK)**

Widthwise Panel Cut		CORE THICKNESS (mm)											
mm	inches	6.4	9.5	12.7	16	19	25	32	38	45	51	57	64
0	0	Standard											
25.4	1	Standard											
50.8	2	Standard											
76.2	3	Standard											
101.6	6	Standard											
Cut Tolerance		± 5 mm											

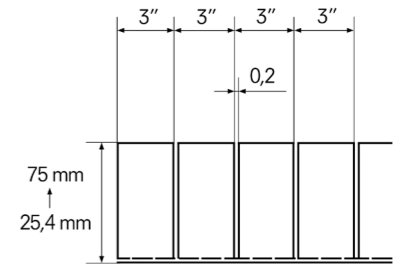

Lengthwise Panel Cut		CORE THICKNESS (mm)											
mm	inches	6.4	9.5	12.7	16	19	25	32	38	45	51	57	64
0	0	Standard											
50.8	2	Standard											
203.2	6	Standard											
Cut Tolerance		± 5 mm											

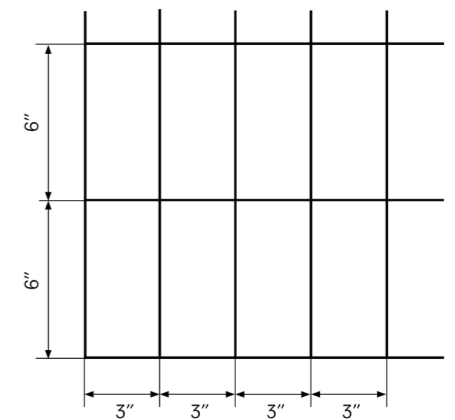

Sheet flexibility ●●   Resin uptake ●●●   Promotes resin flow in infusion ●●   Laminate surface quality ●●●

**Note:** limitations of availability may apply for specific products, densities or thicknesses

## Adaptive ContourKore (ACK)

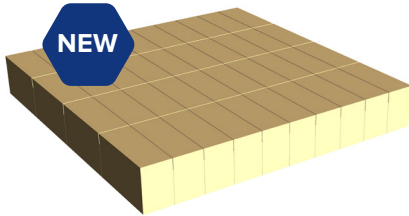

- / 3 x 6" bloc pattern
- / all material > 2"
- / blade kerf width approx. 0.2 mm (knife cut)
- / 44.5 - 76.2 mm thickness
- / saw kerf 1.3 mm

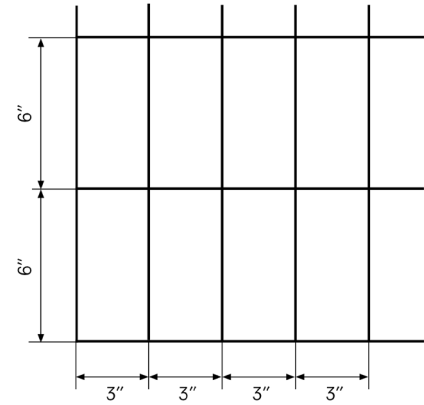
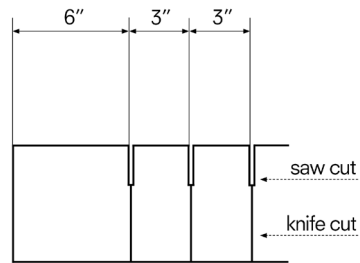

Sheet flexibility ●●●

Resin uptake ●●●

Promotes resin flow in infusion ●●●

Laminate surface quality ●●●